



GARABOS

PLATRERIE - STAFF



3 Générations de savoir-faire et d'exigence

Pierre Garabos, plâtrier traditionnel de formation, crée son entreprise à Carignan dans les années 60. Comme il le souligne encore régulièrement, trainer une corniche sur place ou monter un escalier sur voûte sarrasine était alors aussi normal que réaliser un doublage en plaques de plâtre de nos jours.

Il n'imaginait probablement pas que l'entreprise Garabos ferait partie, 60 ans plus tard, de l'une des dernières entreprises de plâtrerie et de staff de la région bordelaise, faisant d'elle un acteur incontournable dans le domaine.

Grâce à ses deux fils, Bruno et Jean-Claude, l'entreprise Garabos prend dans les années 80 un tournant en se diversifiant dans la plâtrerie sèche. Toutefois, Bruno, dont le cœur de métier reste la plâtrerie traditionnelle paternelle, met un point d'honneur à former de nombreux apprentis, afin de perpétuer les traditions et valeurs artisanales ancestrales du métier.

Cette alliance entre deux métiers distincts, l'un moderne et l'autre traditionnel, permis à l'entreprise de répondre aux attentes de nombreux architectes et l'amena rapidement à se diversifier, cette fois dans le staff, un métier axé autour de la décoration qui consiste à fabriquer et poser des éléments d'ornementation composés de plâtre et de liant végétal.

En 2023, l'entreprise dispose d'un savoir-faire reconnu dans ces trois métiers. Le goût du travail bien fait, du beau, et les défis techniques sont devenus les moteurs de toute l'équipe. Chaque challenge technique ou esthétique représente pour nous un nouveau moyen de mettre à l'épreuve nos compétences, notre technicité ou notre ingéniosité.

Le staff, grâce à l'énorme quantité de possibilité qu'il offre, représente pour l'entreprise un incroyable terrain de jeu, un inépuisable champ d'expression pour nos compagnons. Il est donc logique que l'entreprise vous présente aujourd'hui, sa propre gamme de staff.

Nous espérons que si cette dernière vous permet de choisir des modèles pour vos projets, elle ne limitera pas votre imagination, car les petites fantaisies de nos clients, ou les grandes, sont les raisons pour lesquelles nous nous levons avec le sourire le matin.

Le staff chez Garabos

Le staff est un matériau à base de plâtre armé de fibre naturelle. Inventée au 19^{ème} siècle, cette technique de moulage et de fabrication permet de créer et recréer des ornements de toutes tailles, formes ou styles.

Bien que cette technique de moulage du plâtre soit perçue comme une facette traditionnelle des métiers de la plâtrerie, l'alliance entre les nouvelles technologies (BIM, scan 3D, modélisation des ouvrages, recours à la réalité augmentée sur chantier etc...) et le staff, est possible, rendant au staffeur sa place au sein de projets neufs à hautes valeurs ajoutées.

Notre équipe est composée du bureau d'étude et de l'atelier. Les deux Mathieu, Hervé, Laura et Joël élaborent les calibres et les moules, destinés à exaucer tous les désirs des architectes et décorateurs.

Le bureau d'étude quant à lui, grâce à l'expérience de Jean-Claude, celle de Luc et David et à l'attention d'Allison, analyse les projets afin de proposer à nos clients les méthodes les plus adaptées et les plus en adéquation avec ses attentes tant esthétiques que techniques.

La force de Garabos réside dans l'association parfaite de ces fonctions : la compétence technique, l'analyse des contraintes, et les conseils judicieux.

Challengez-nous !

Une gamme historique

Rentrer dans un atelier de staff, c'est un peu comme franchir les portes d'un antiquaire de la rue Notre Dame. On y trouve de tout, de temps et d'époques plus ou moins révolus, et seul un fin connaisseur est réellement capable de comprendre la valeur véritable de ce qui s'y trouve.

En effet, le staffeur a l'encombrante manie de systématiquement récupérer, démonter, ou mouler tout ornement qu'il trouve ou répare sur un chantier afin de toujours disposer d'un double, pour être en mesure de le reproduire ailleurs.

L'atelier de l'entreprise Garabos ne déroge pas à ces règles. On peut y trouver bon nombre de corniches, de moulures, de rosaces ou de panneautages muraux que nous avons préservé de la destruction ou restitué à l'identique dans des lieux emblématiques du bordelais.

La gamme que nous vous proposons donne un petit aperçu des profils que nous stockons dans nos archives. Notre objectif est que cette gamme s'étoffe dans le temps, afin que chacun, en fonction de son projet, de la taille des pièces à décorer, du style ou d'une époque, puisse y trouver son bonheur.

Sommaire

/ 1 Les corniches

Nouveautés x La Racine p.8

Art Déco p.19

Doucine p.22

Gorge p.26

Larmier p.36

/ 2 Les rosaces p.44

/ 3 Moulures et cimaises p.54



Les corniches

Nouveautés



Cubzac
67.50 € ht/ml



Gensac
60.75 € ht/ml



Cussac
74.25 € ht/ml



Guillac
60.75 € ht/ml



Générac
58.05 € ht/ml



Listrac
54.00 € ht/ml

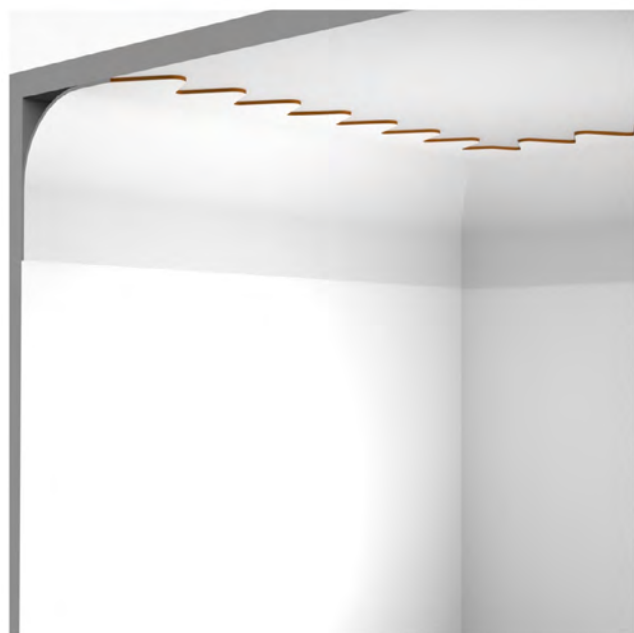

Pessac
121.50 € ht/ml



Savignac
83.70 € ht/ml

19.5

19.5

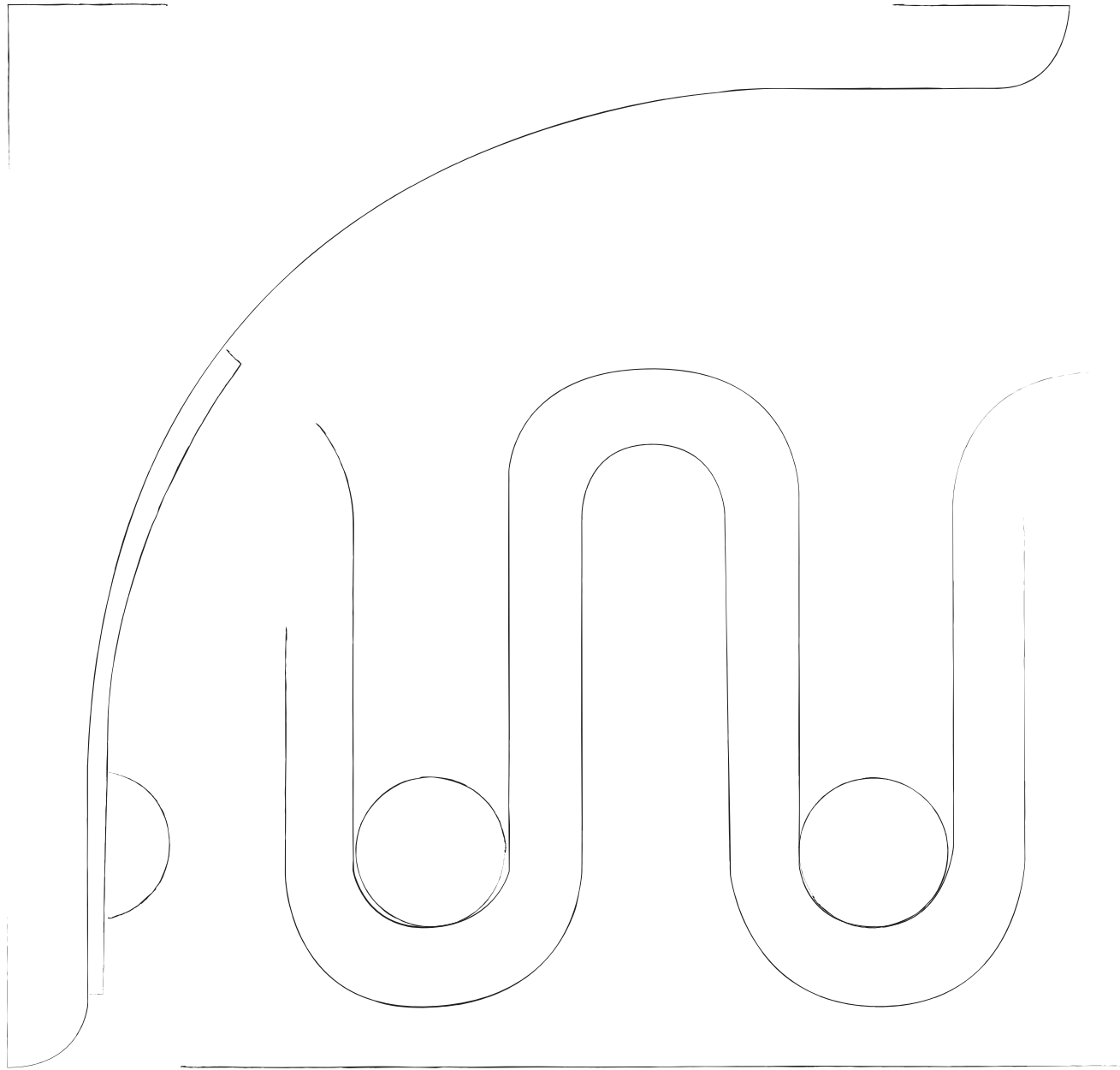

Cubzac

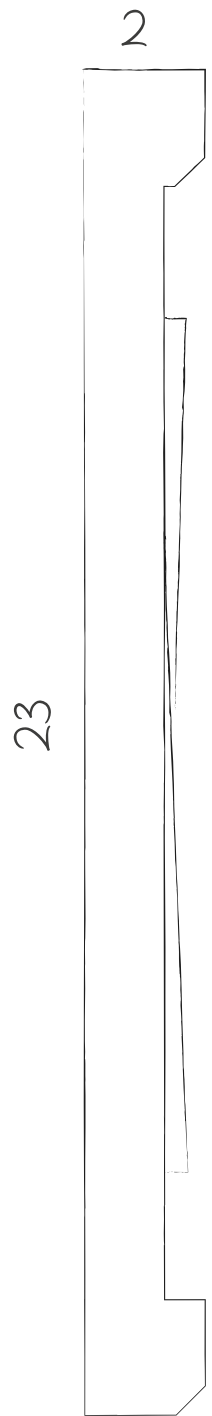

Gensac

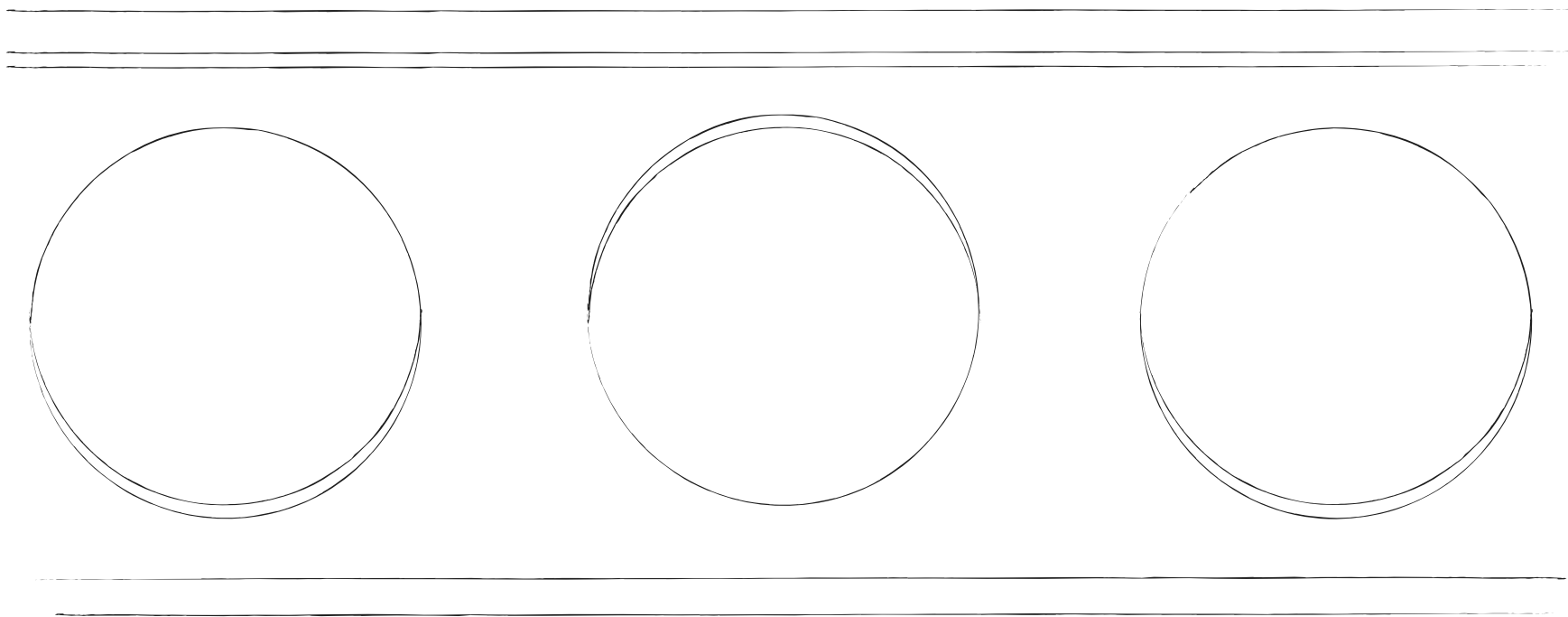

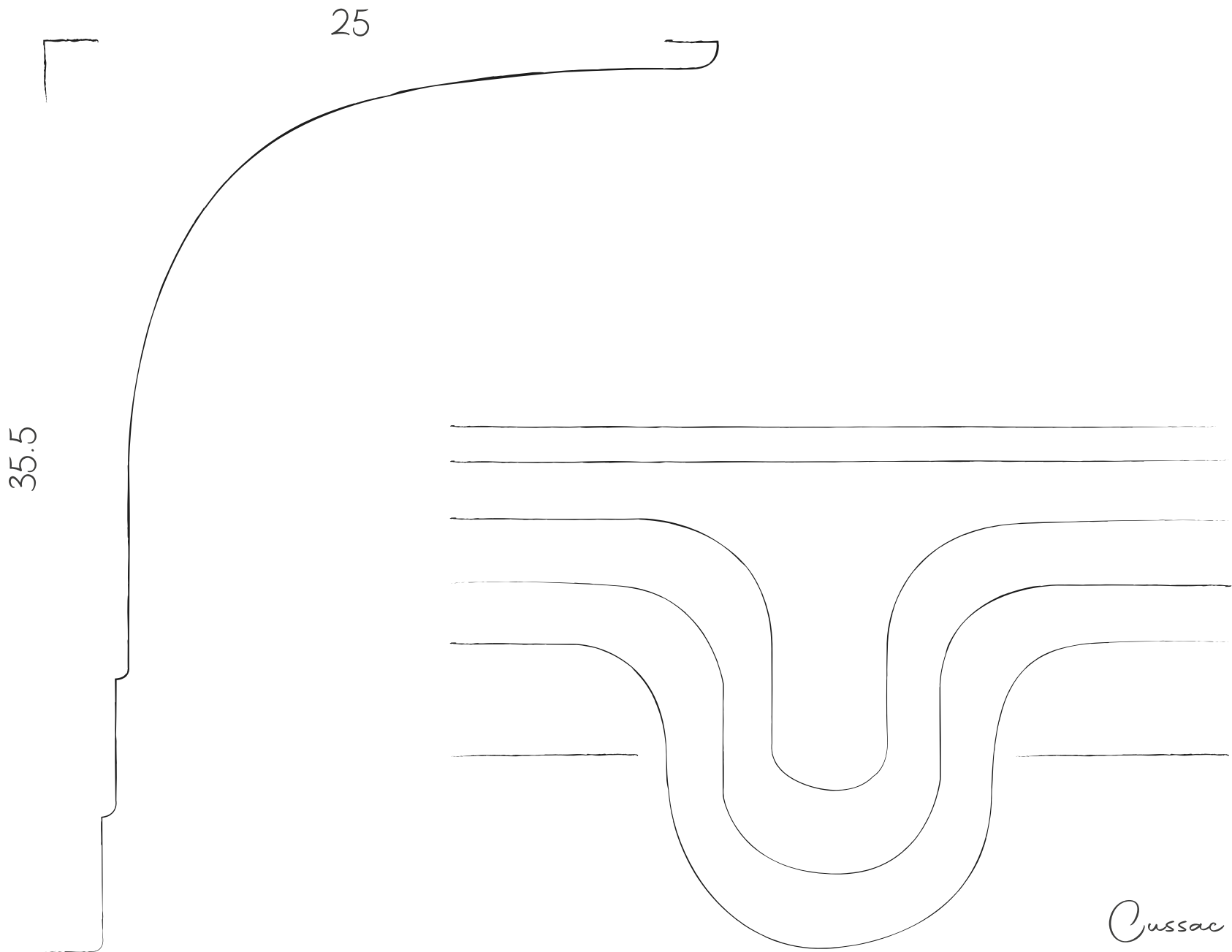

Cussac

23

3

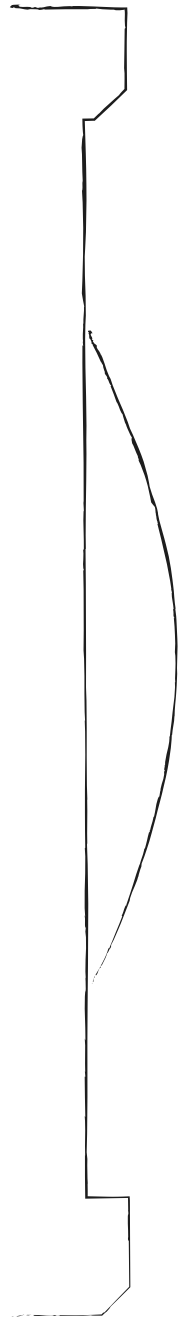

Guillac

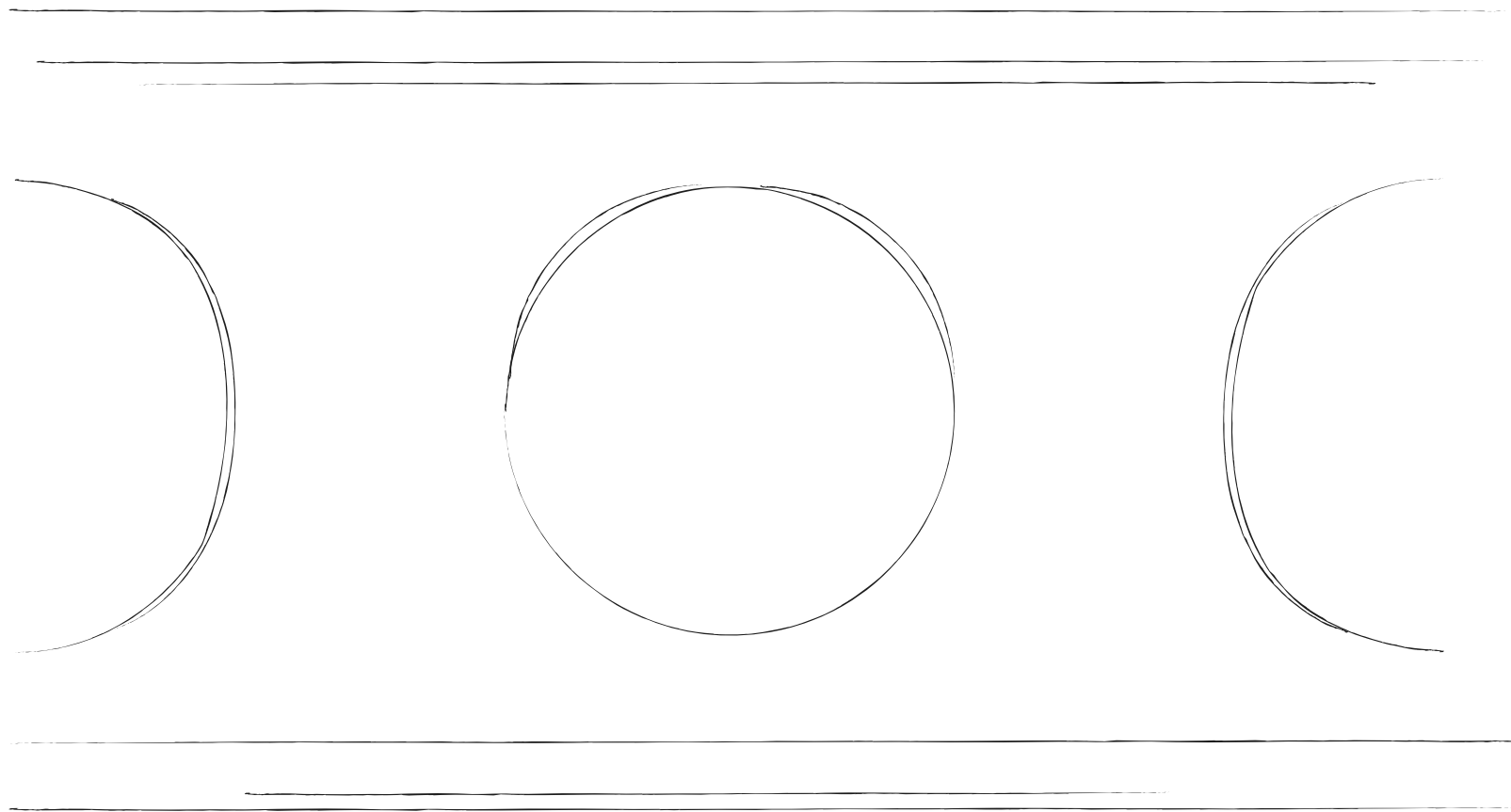

51

Pessac

42.5

Vendu en deux pieces
gorge + ornements

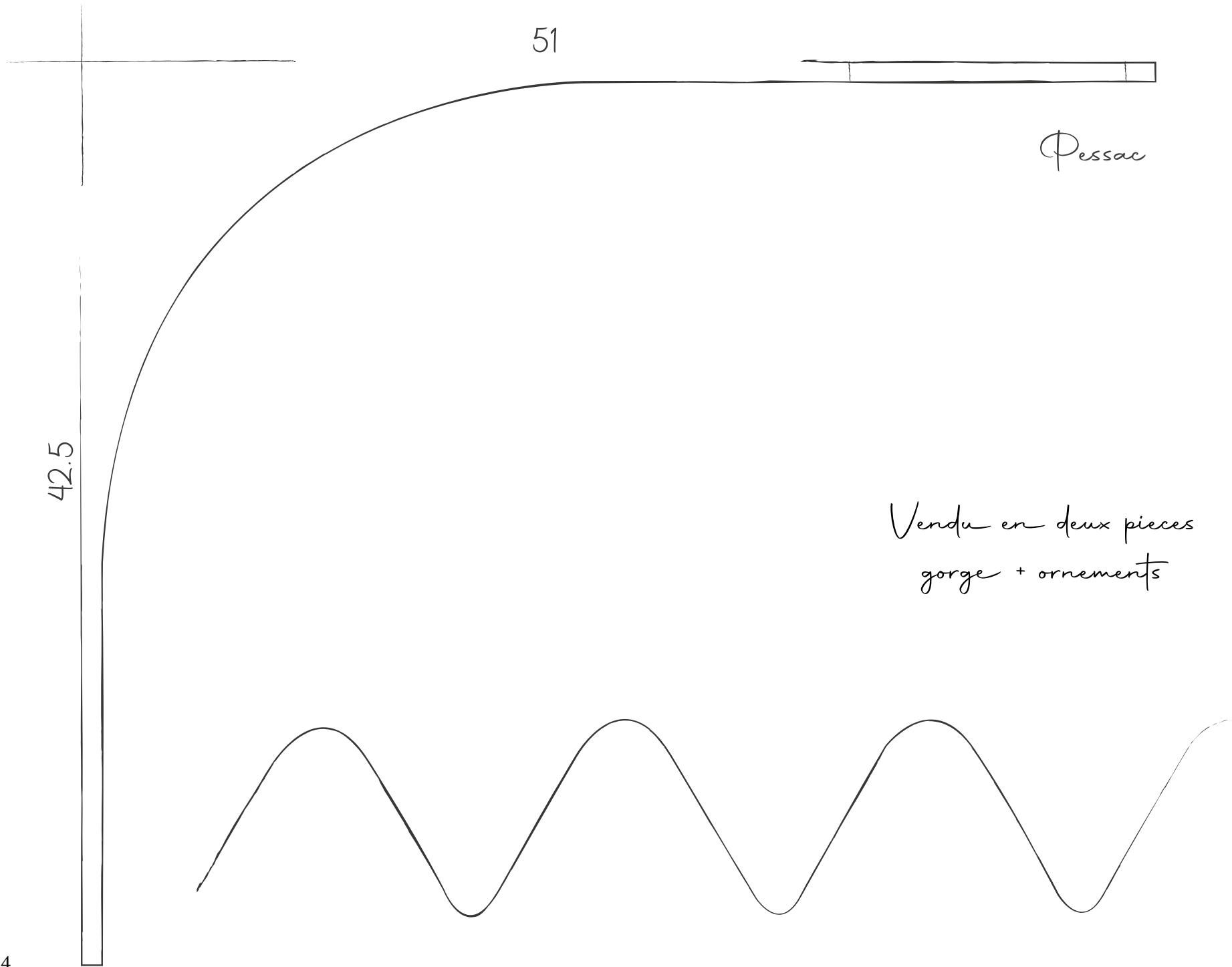

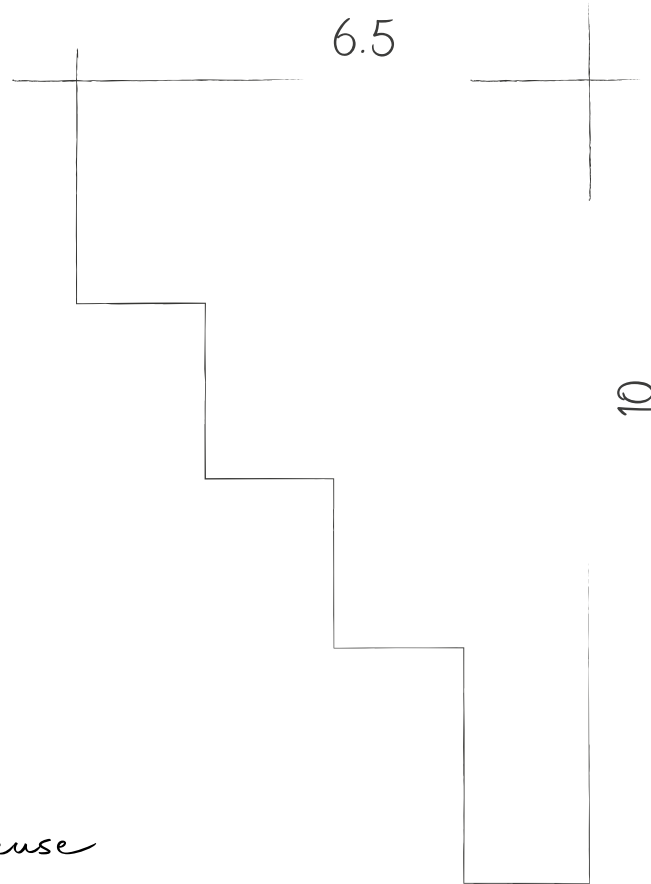

corniche lumineuse

Savignac

corniche lumineuse

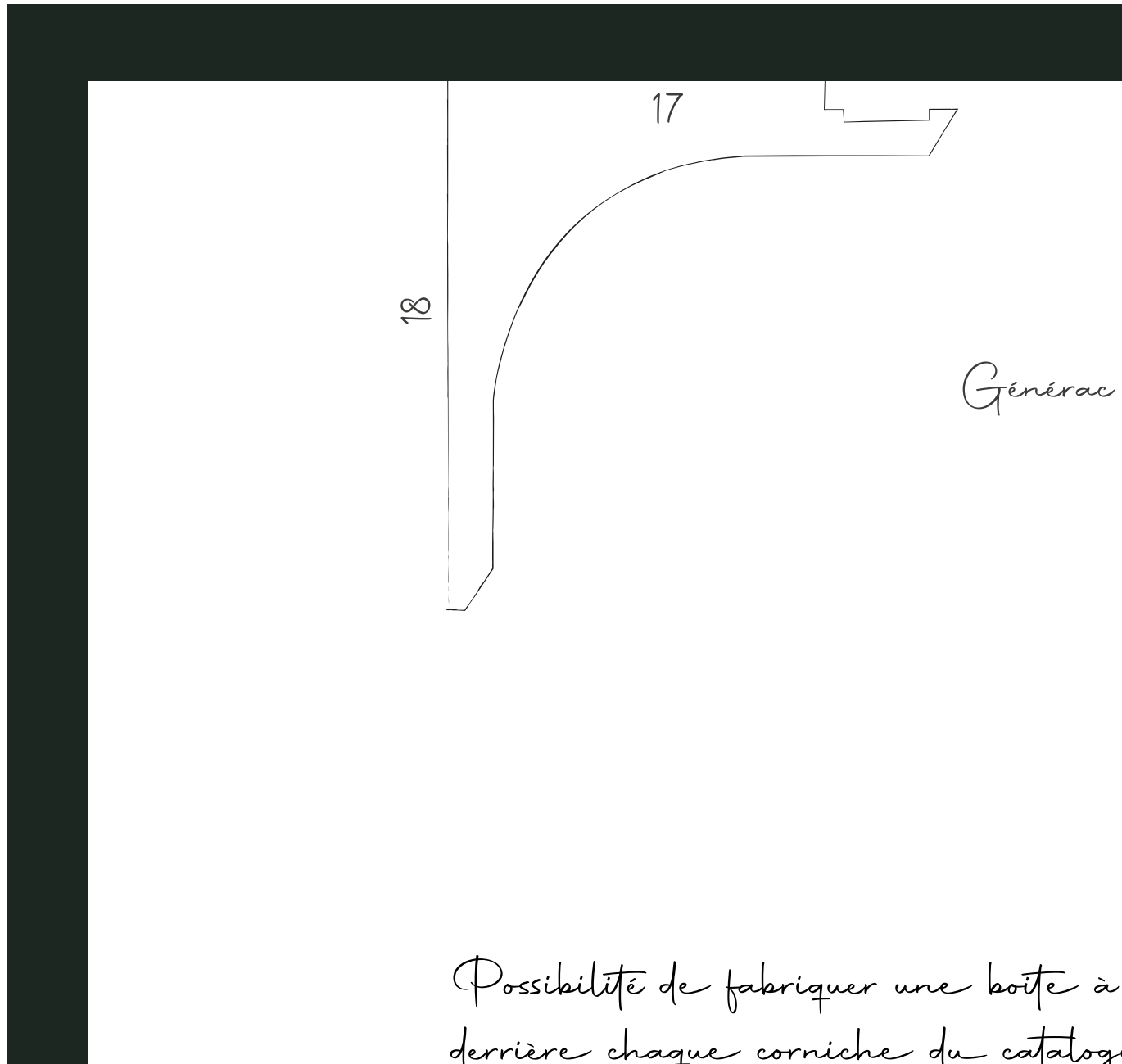

Possibilité de fabriquer une boîte à rideaux derrière chaque corniche du catalogue.

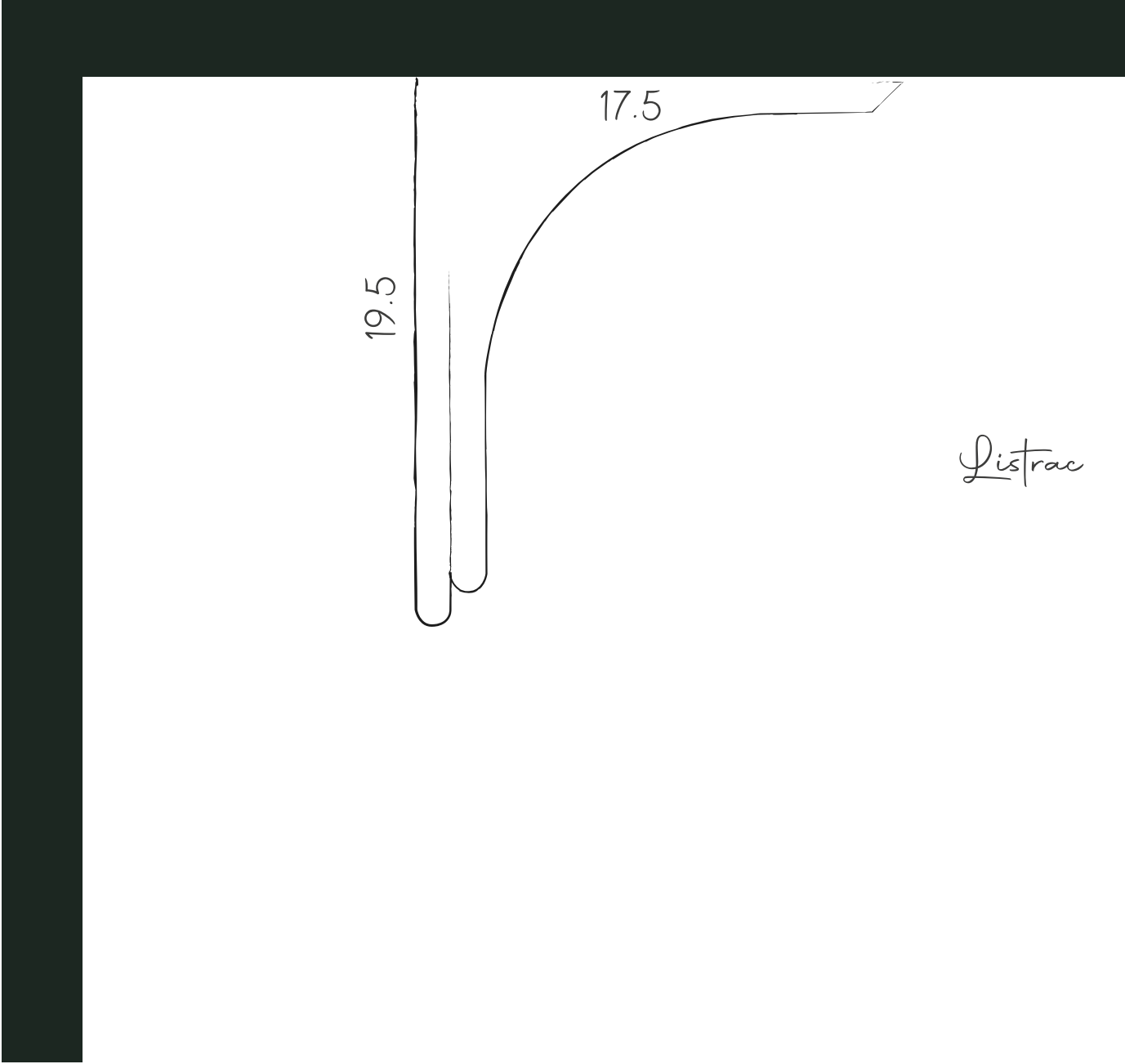



Art Déco

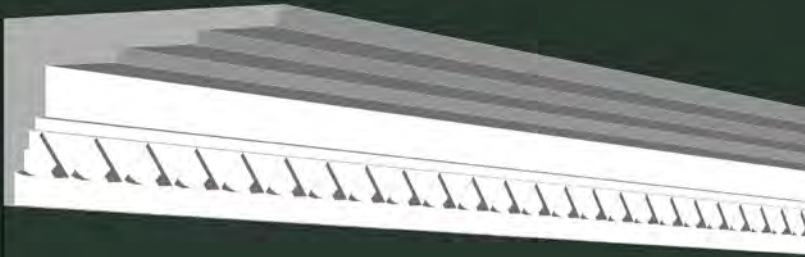

Abzac
67.50 € ht/ml



Balizac
60.75 € ht/ml

27.3

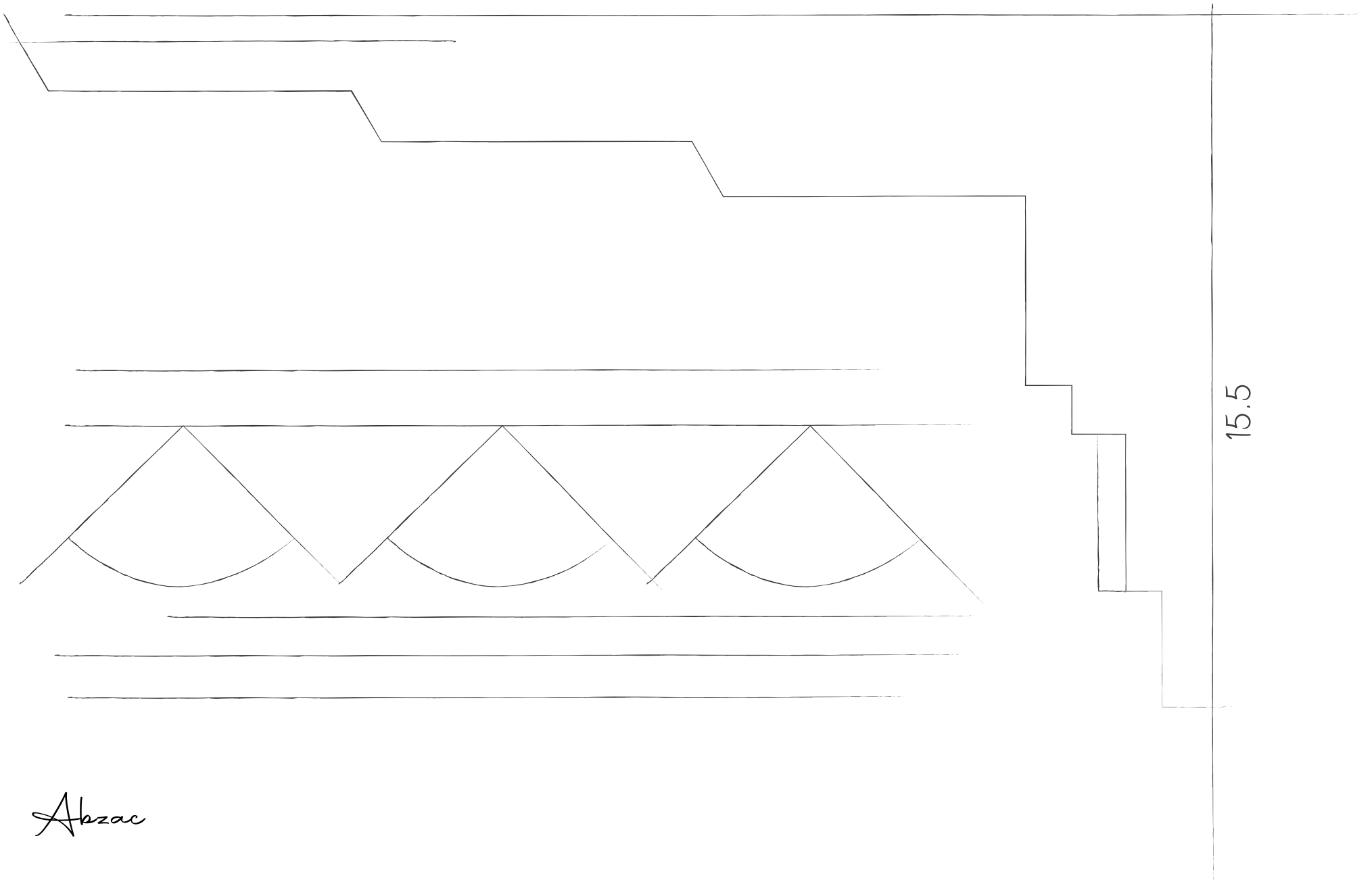

15.5

Abzac

24.2

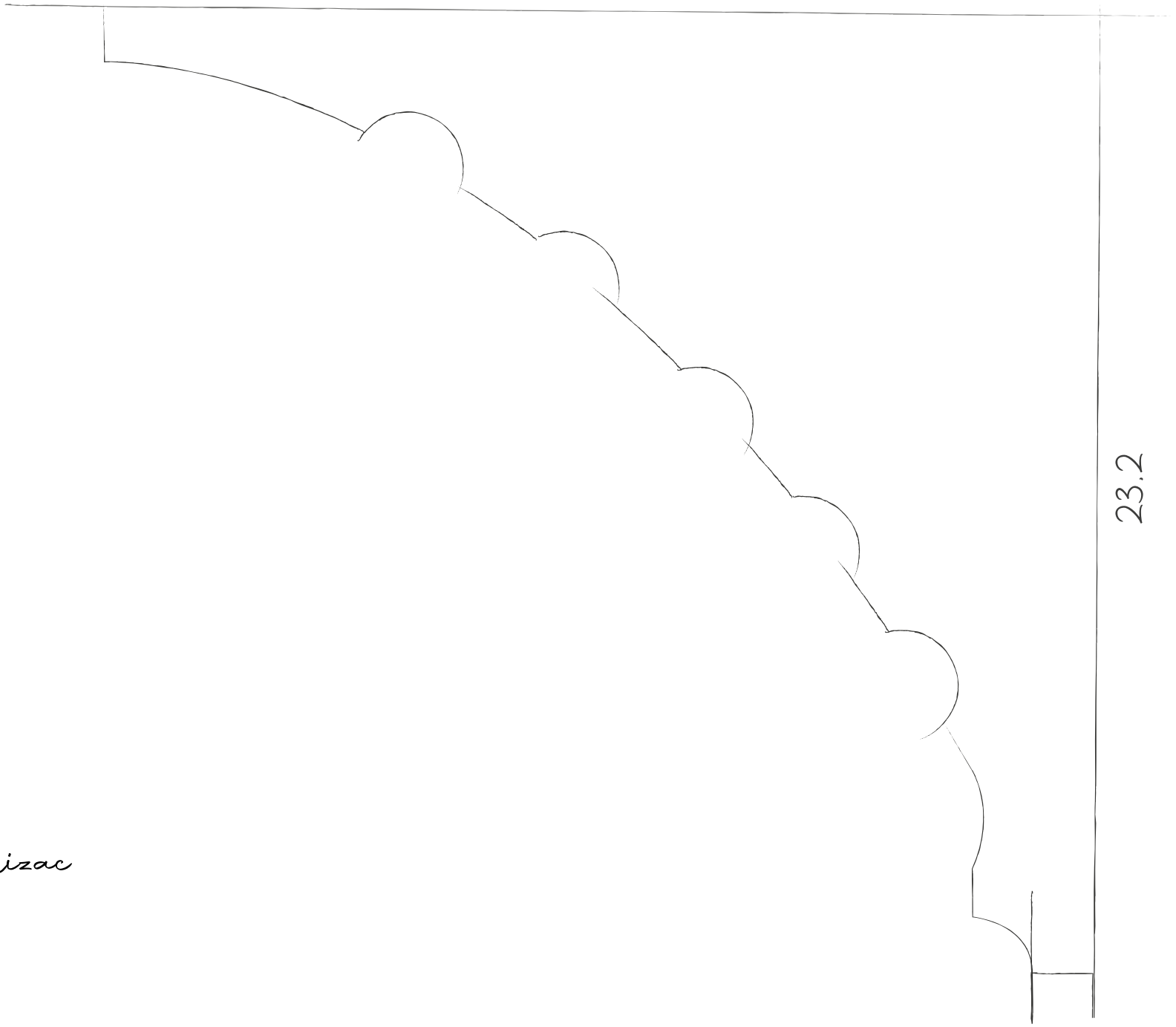

23.2

Balizac

Doucines



Bouliac
48.60 € ht/ml



Cabanac
35.10 € ht/ml



Donnezac
24.30 € ht/ml

17.3

19.2

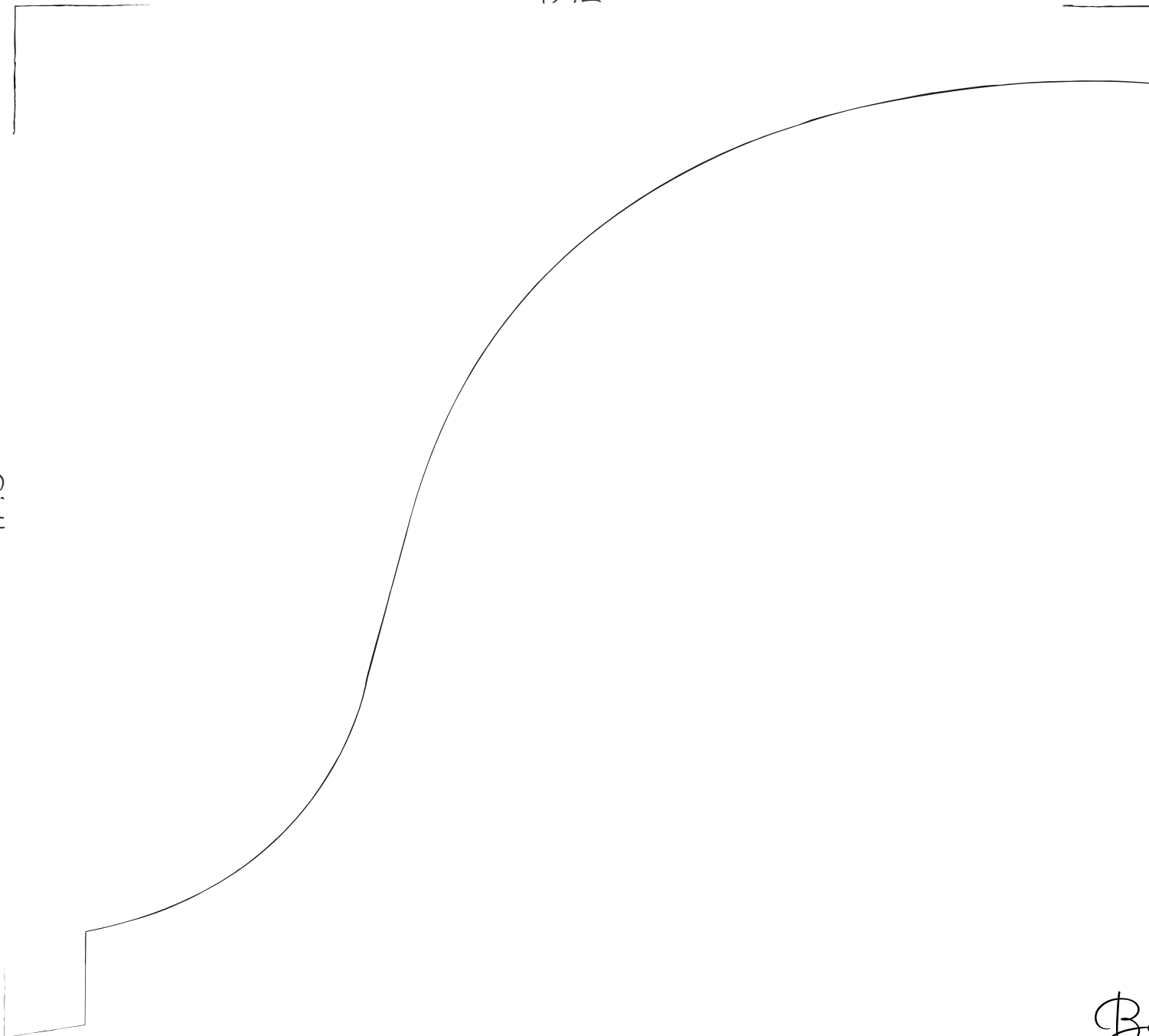

Bouliac

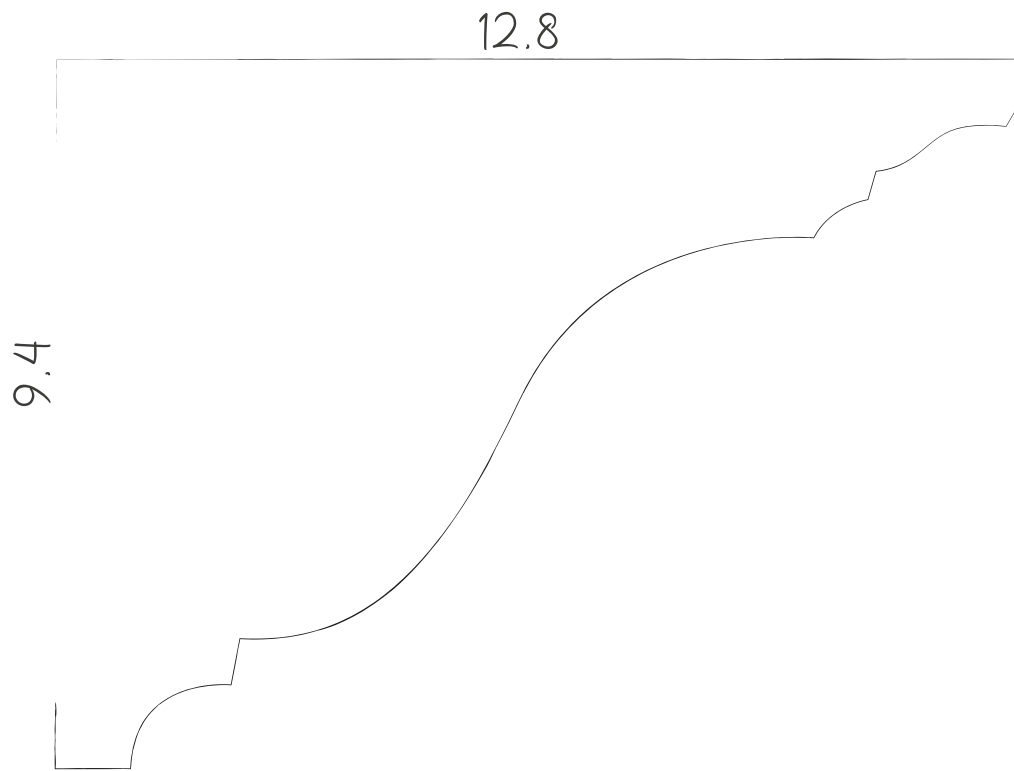

Cabanac

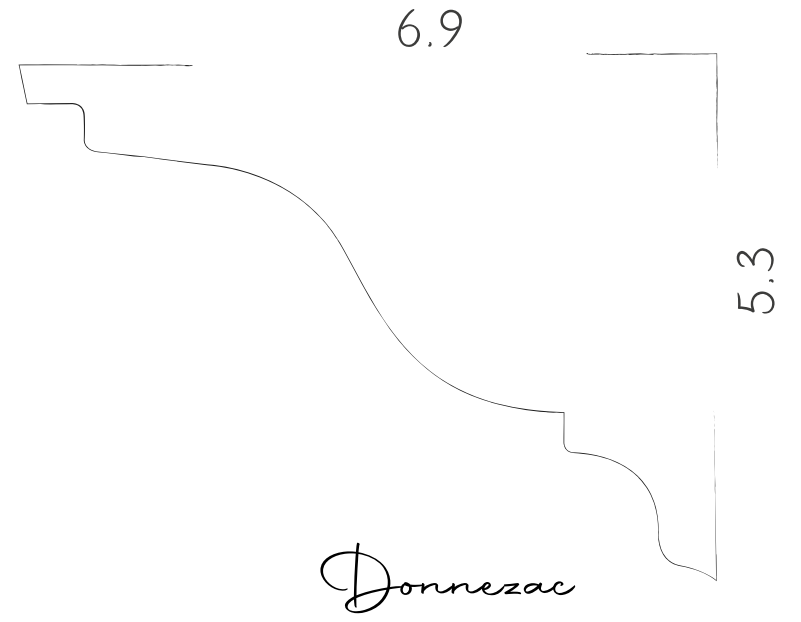

Donnezac



Gorges



Cadarsac
29.70 € ht/ml



Floirac
27.00 € ht/ml



Fronsac
29.70 € ht/ml



Gabarnac
40.50 € ht/ml



Montignac
67.50 € ht/ml



Pauillac
54.00 € ht/ml



Loupiac
67.50 € ht/ml



Podensac
67.50 € ht/ml



Sadirac
59.40 € ht/ml

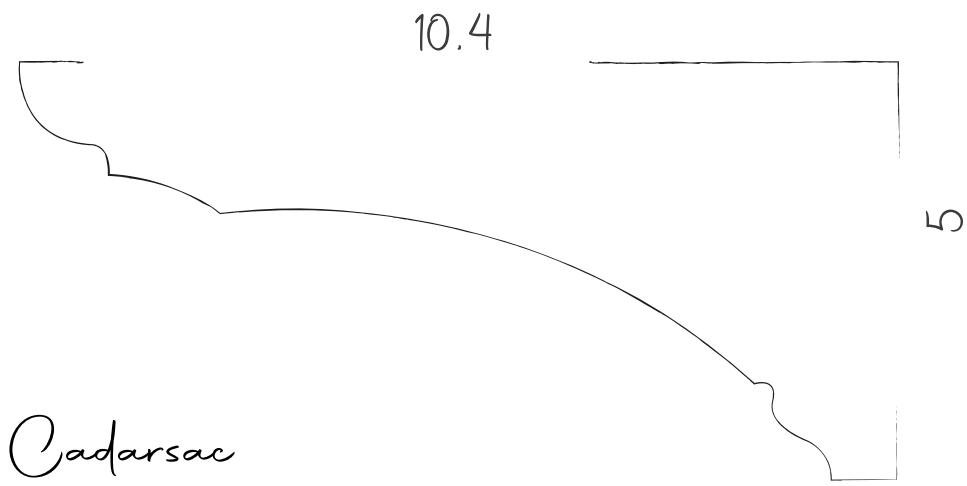

Cadarsac

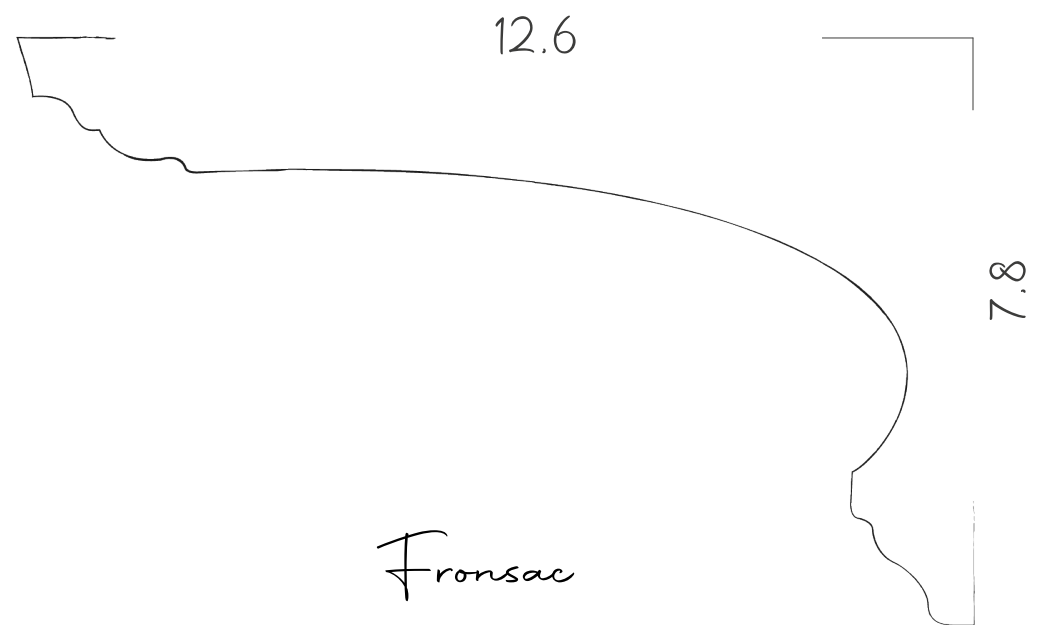

Fronsac

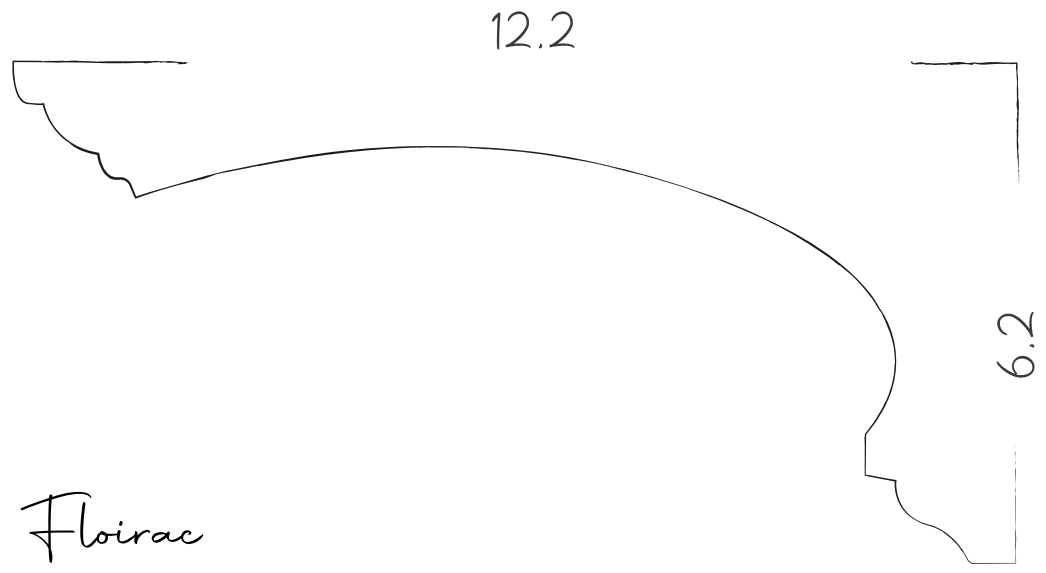

Floirac

Gabarnac

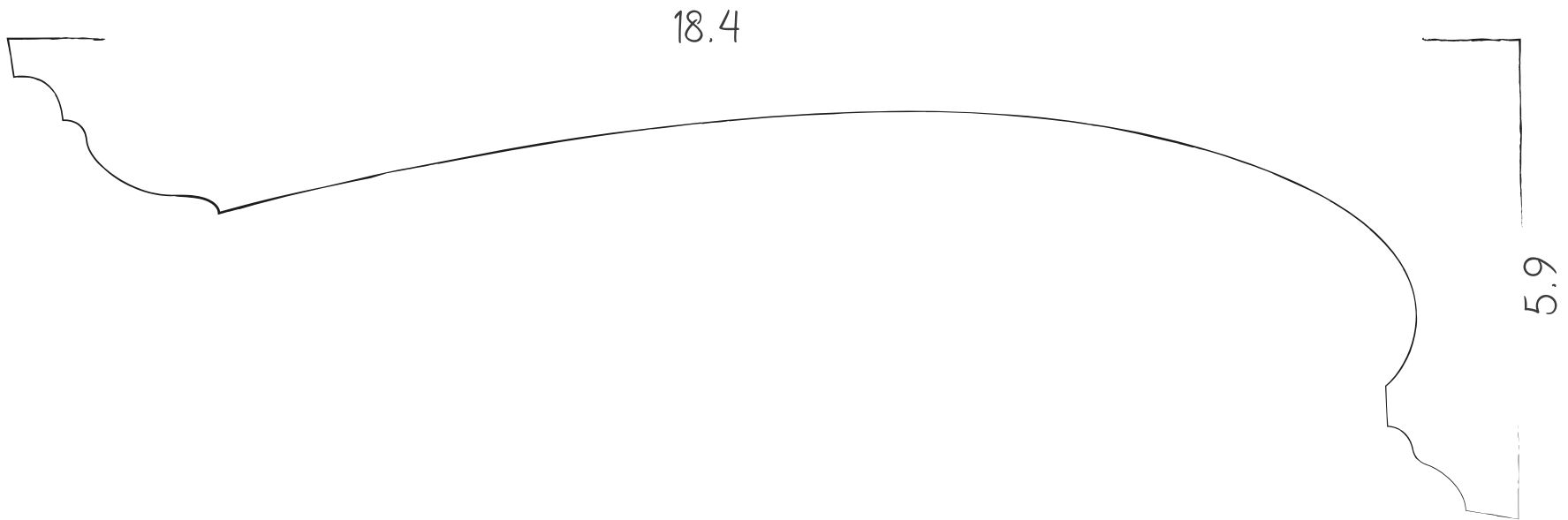



Pavillac

23



22

Montignac

26.5

21.5

Podensac

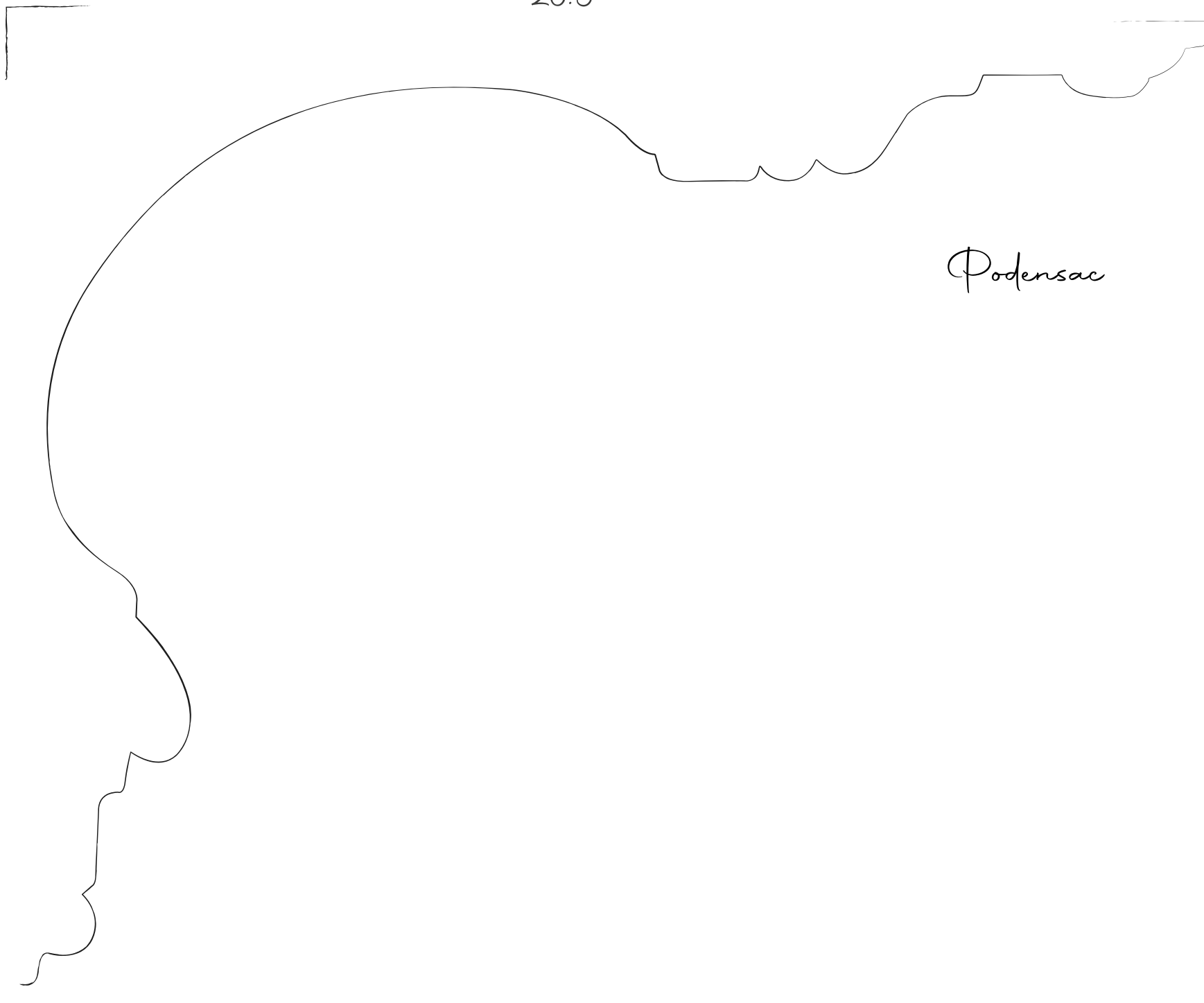

27.2

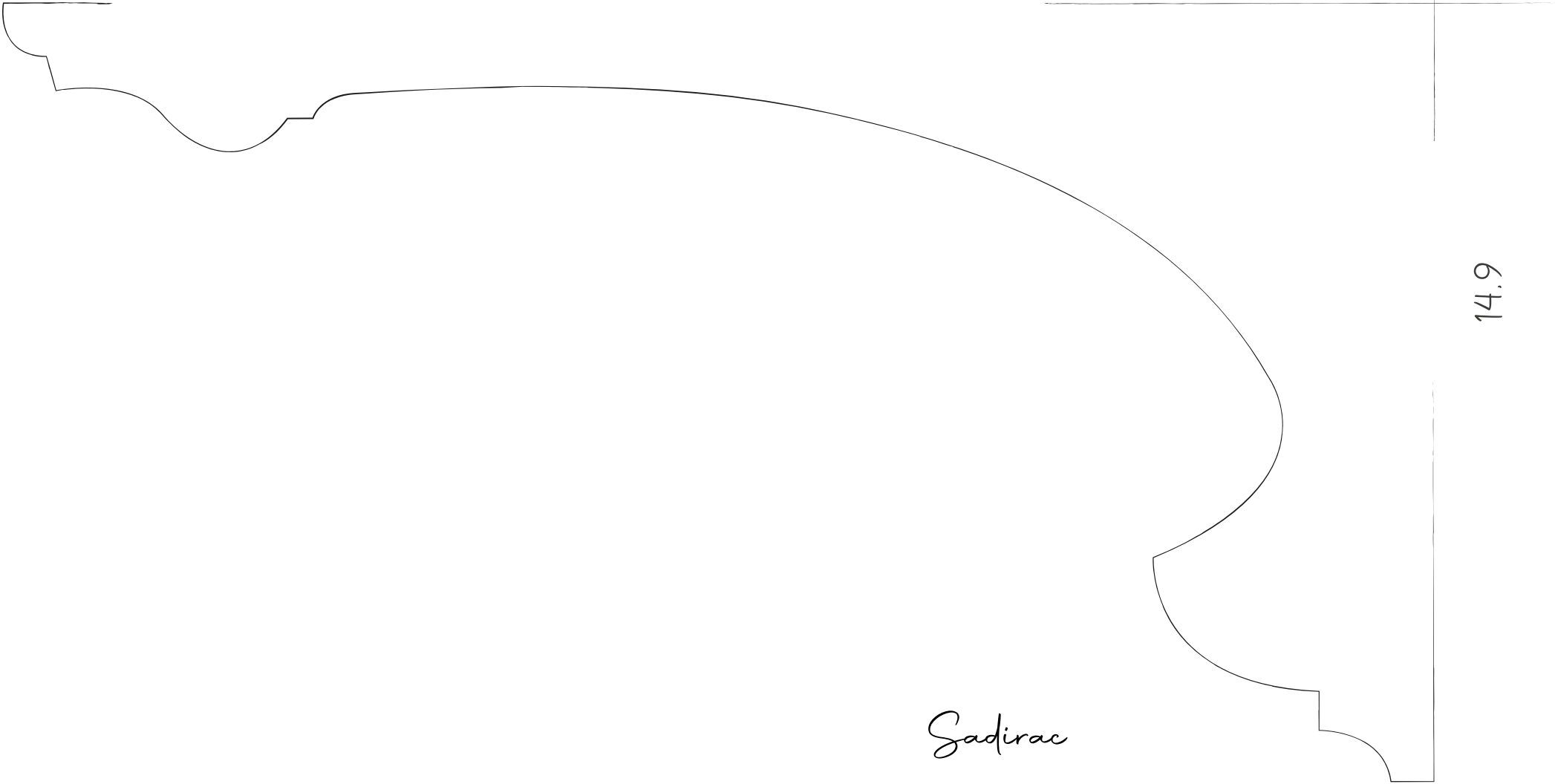

14.9

Sadirac

34

17.8

30.6

Loupiac

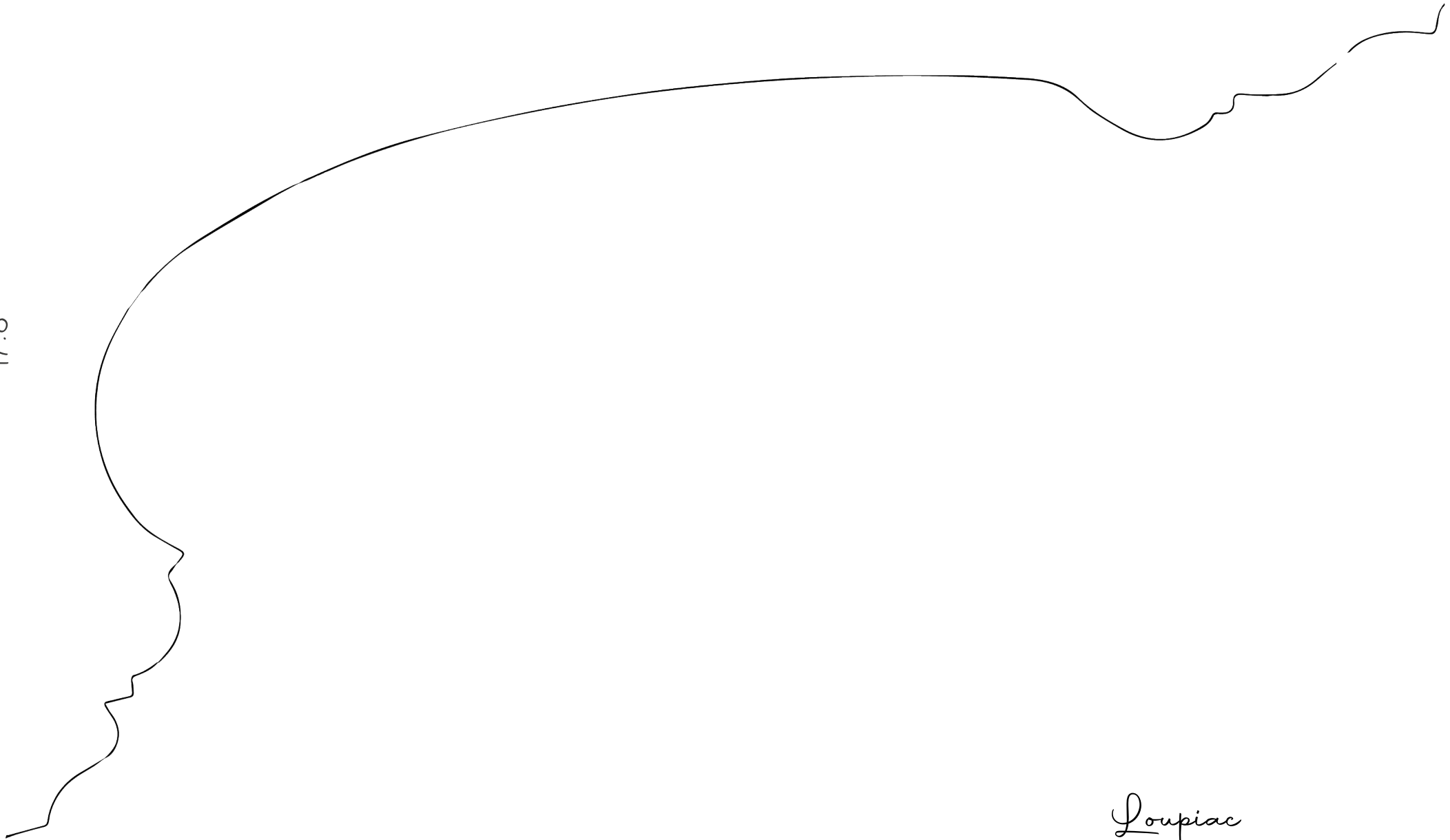



Jarmiers



Naujac
45.90 € ht/ml



Tabanac
45.90 € ht/ml



Verac
33.75 € ht/ml



Barsac
47.25 € ht/ml



Cantenac
47.25 € ht/ml



Yvrac
33.75 € ht/ml

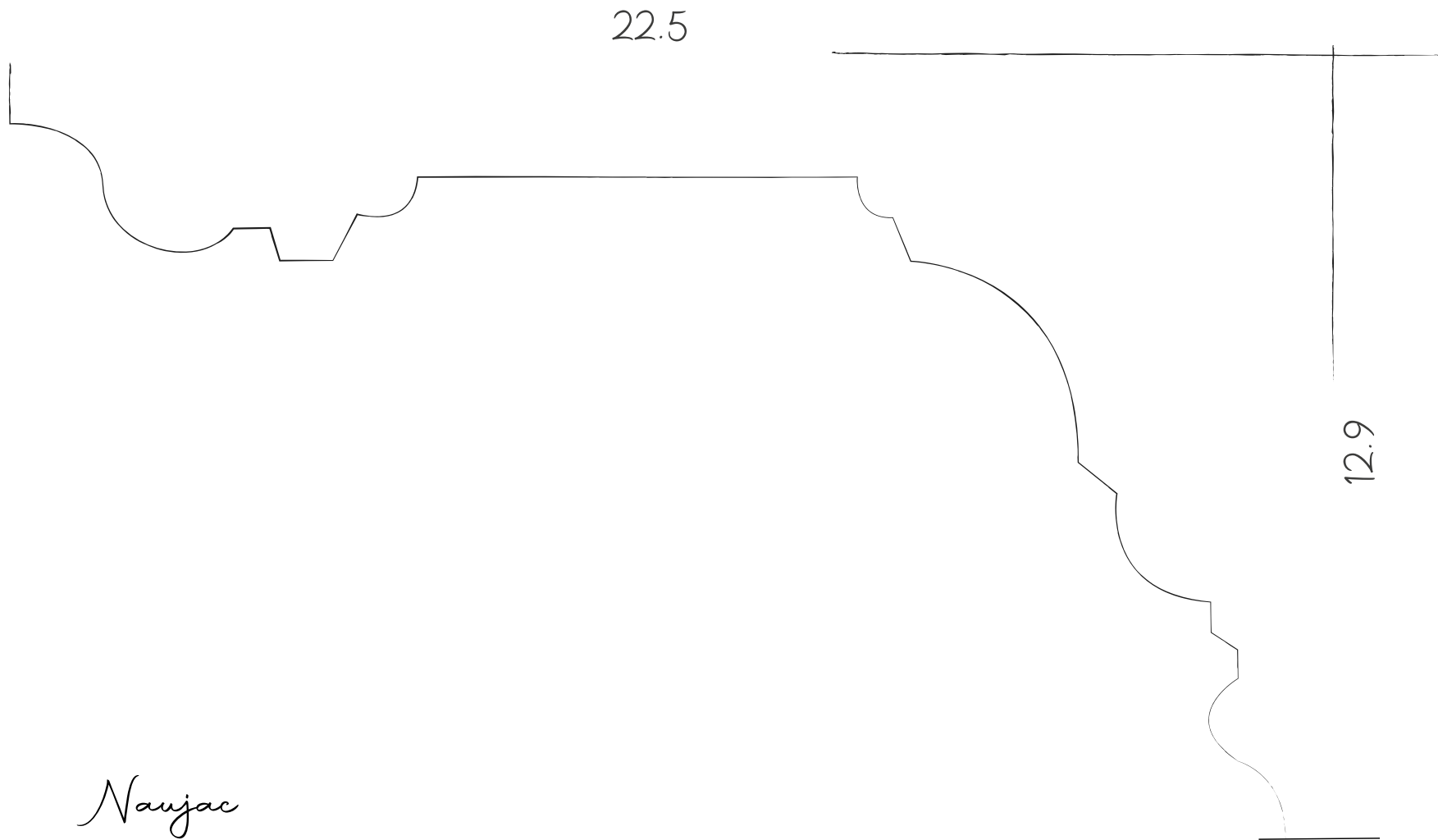

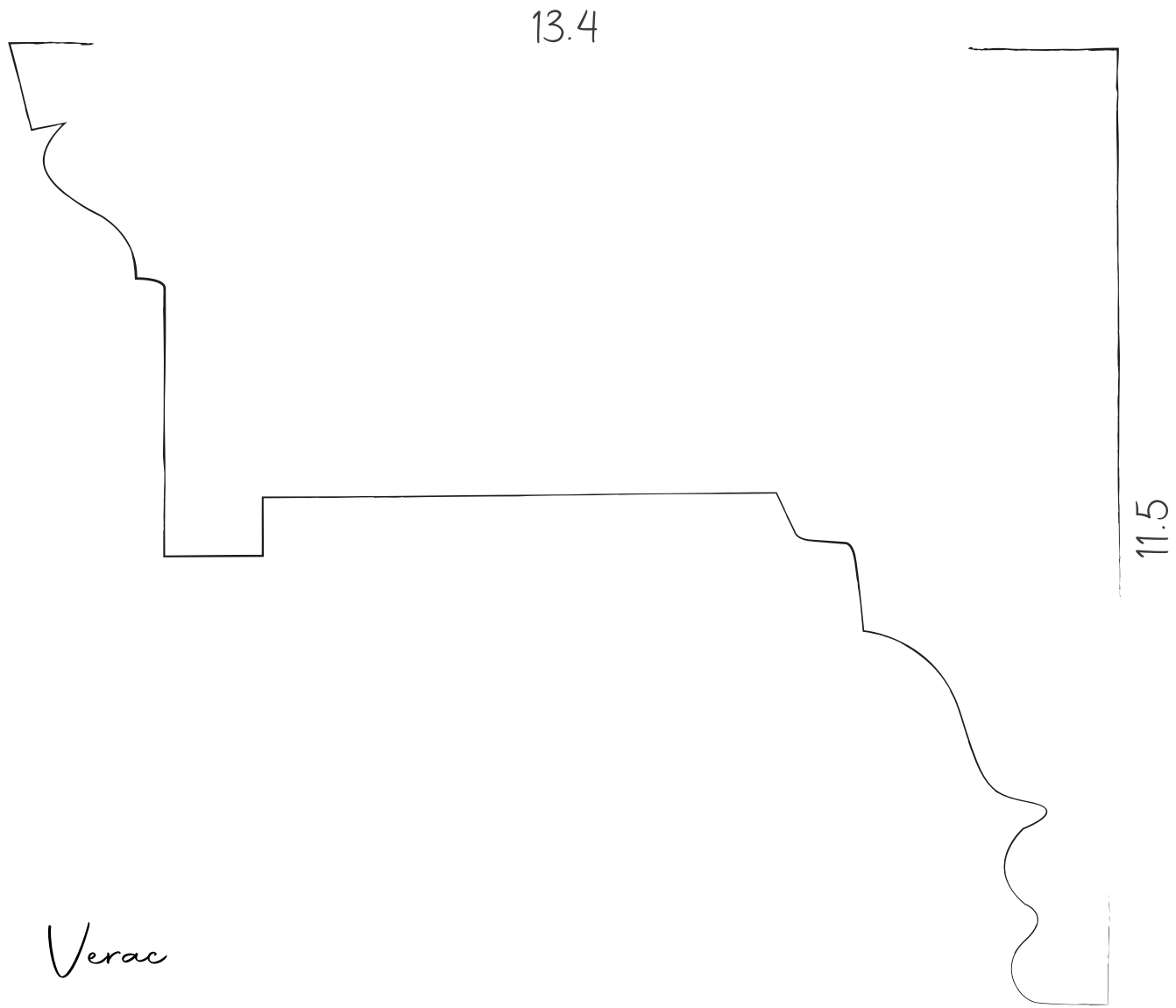

14.2

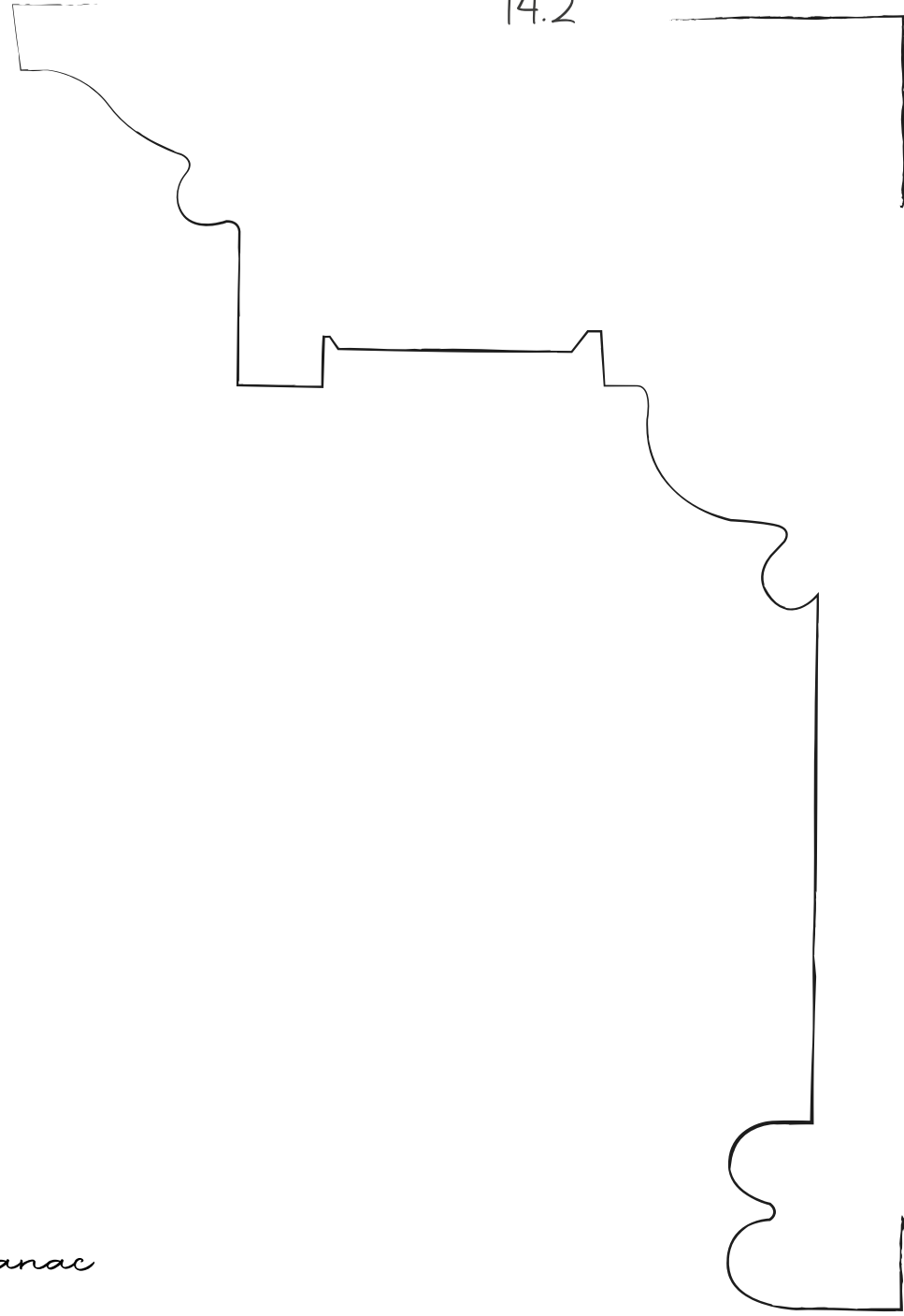

20.5

Tabanac

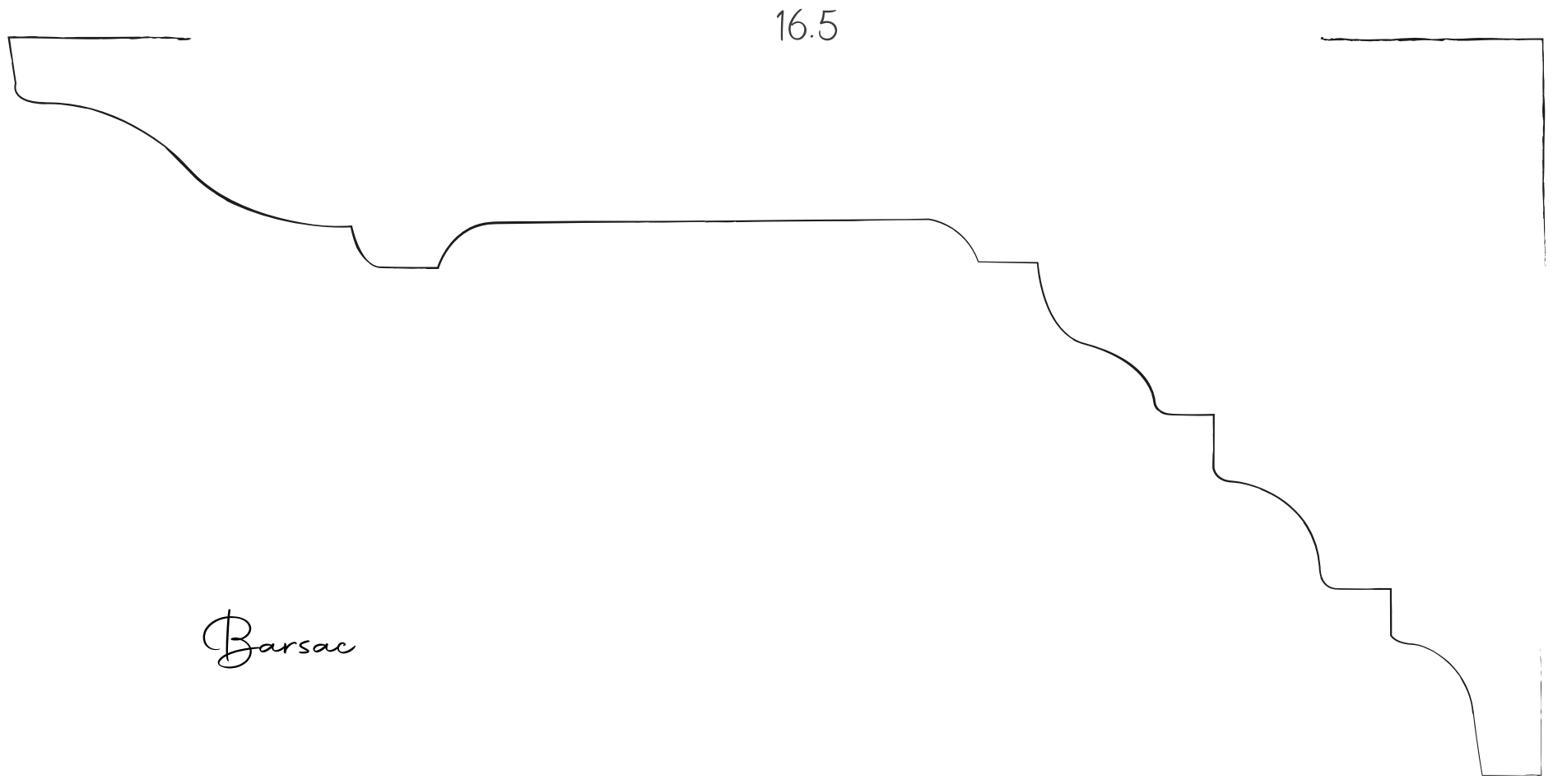

16.5

7.9

Barsac

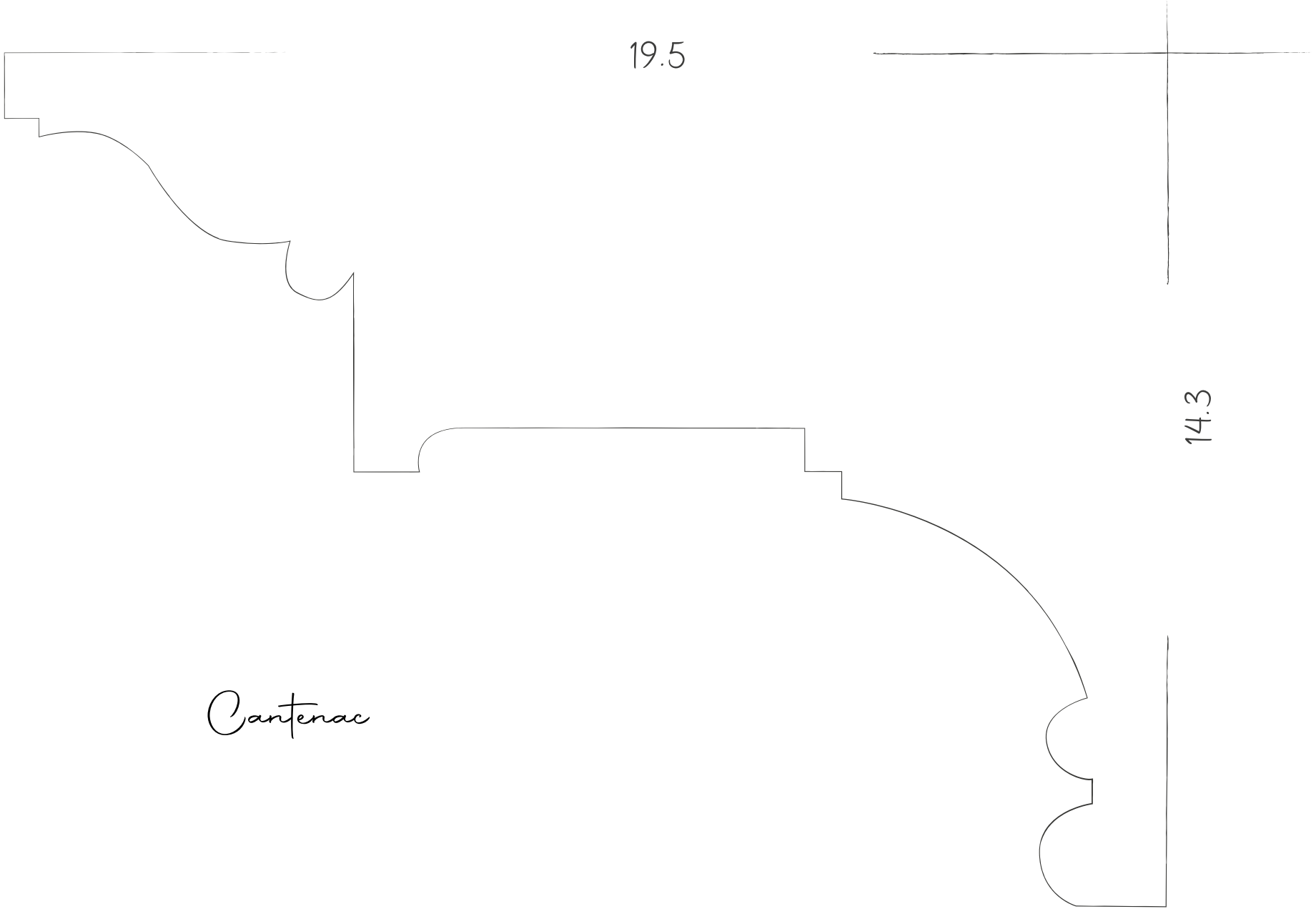

19.5

14.3

Cantenac

Gurac

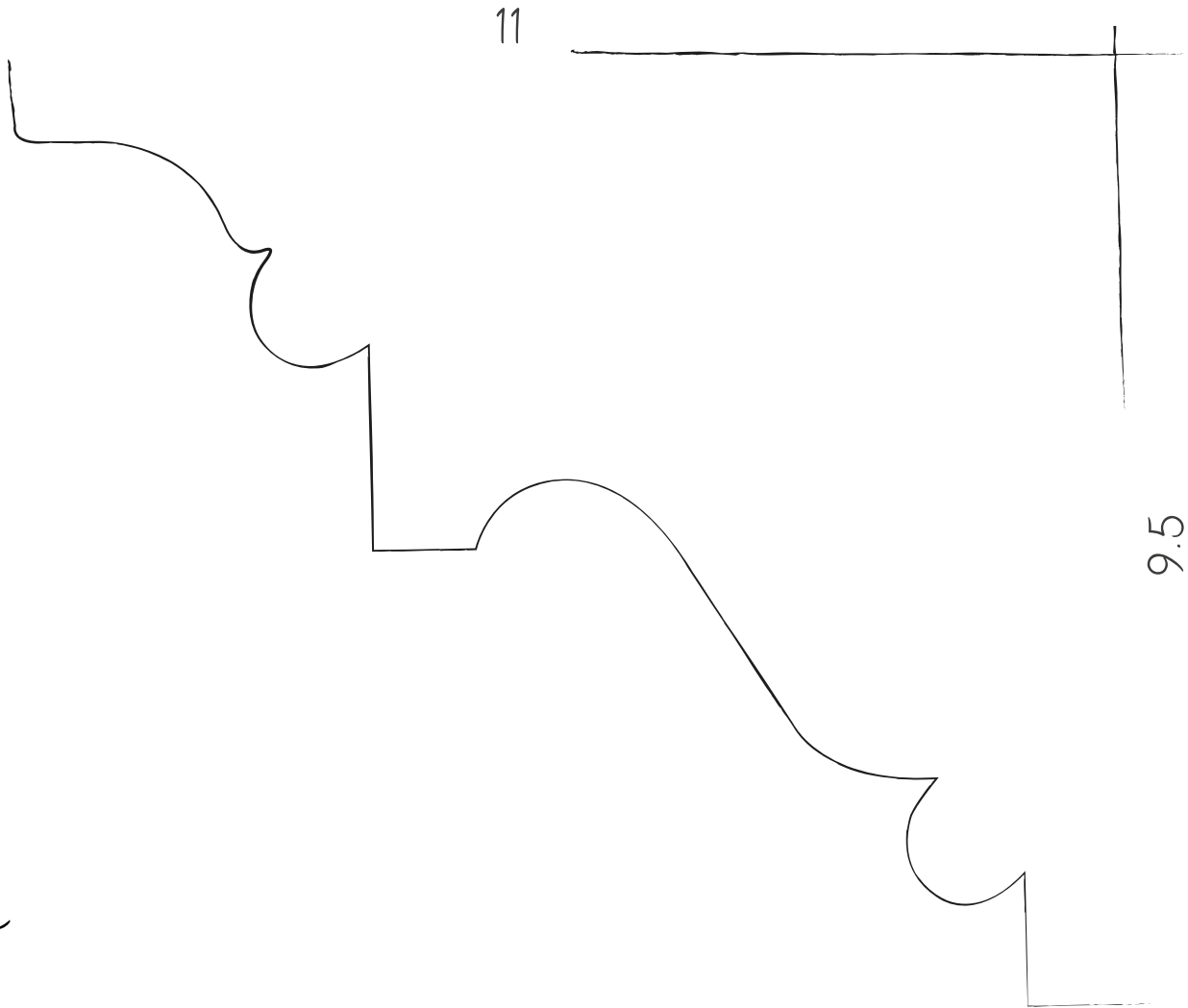

Les Rosaces



0-013



BEAUTIRAN

148.5€ / UHT

44 cm

35 cm

BEGADAN

114.75 € / UHT



CAPIAN

101.25 € / UHT

27 cm





35 cm
50 cm

LANGOIRAN

135.00 € / UHT



BONNETAN

202.50 € / UHT

54 cm



LÉOGNAN

229.50 € / UHT

58 cm

LE PIAN

310.50 € / UHT

75 cm



CAMIRAN

229.50 € / UHT

60 cm





MONTUSSAN
567.00 € / UHT

50 cm
100 cm



CARCANS
364.50 € / UHT

82 cm





CARIGNAN

445.50 € / UHT

100 cm

ROAILLAN

445.50 € / UHT

100 cm





CAUDÉRAN

924.75 € / U

140 cm



CARDAN
945.00 € / U



Les cimaises et moulures





PREIGNAC

21.60 € /ml

4.5



6.1



SOULIGNAC

25.65 € /ml

4.6

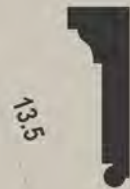

13.4



CADAUJAC

29.70 € /ml

6.7



9.6

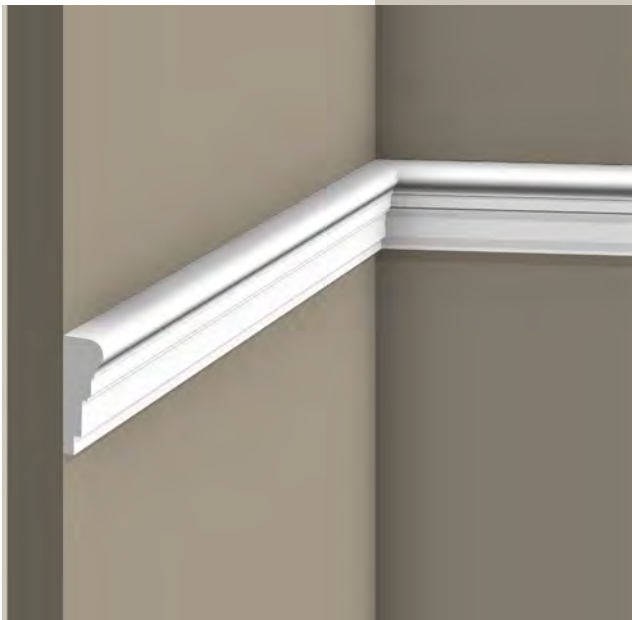

CADILLAC

20.25 € /ml

3.5



9.1

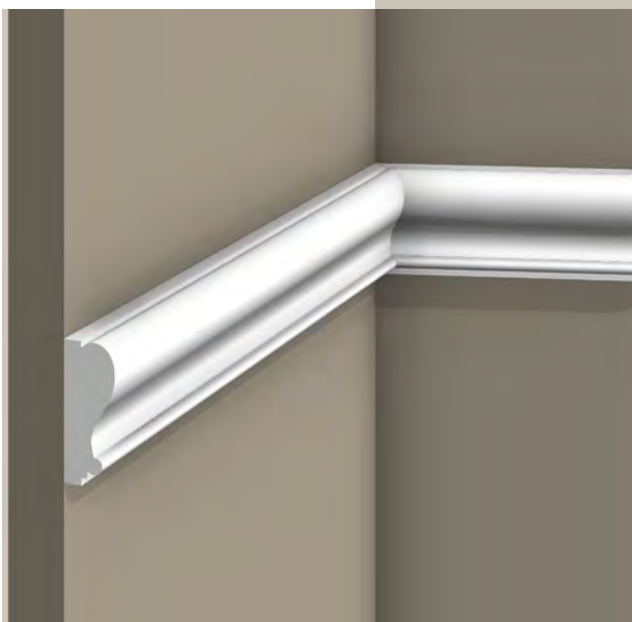

PLASSAC

24.30 € /ml

4.5



11.1



CIVRAC

24.30 € /ml

3.1



12.1



COIRAC

20.25 € /ml

3.3



7.9



PERISSAC

21.60 € /ml

2.6



10



VALEYRAC

20.25 € /ml

2.9



5.1



POMPIGNAC

14.85 € /ml

2.2



5



DONZAC

21.60 € /ml

2.2



8.5



REIGNAC

20.25 € /ml

2



6.5



SAUVIAC

16.20 € /ml

2.1



5.1

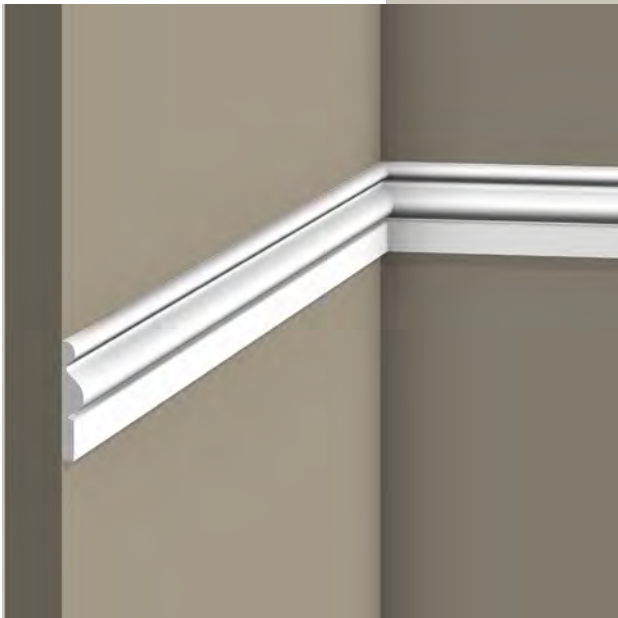

GORNAC

20.25 € /ml

1.9



6.8



CAVIGNAC

14.85 € /ml

1.8



5



MARTILLAC

22.95 € /ml

1.7

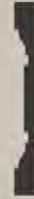

14.4



NÉAC

14.85 € /ml

1.7



5.5



GAURIAC

13.50 € /ml

1.6



5.2



JUILLAC

16.20 € /ml

1.7



6.2



FRONTENAC

14.85 € /ml

1.2



5.4

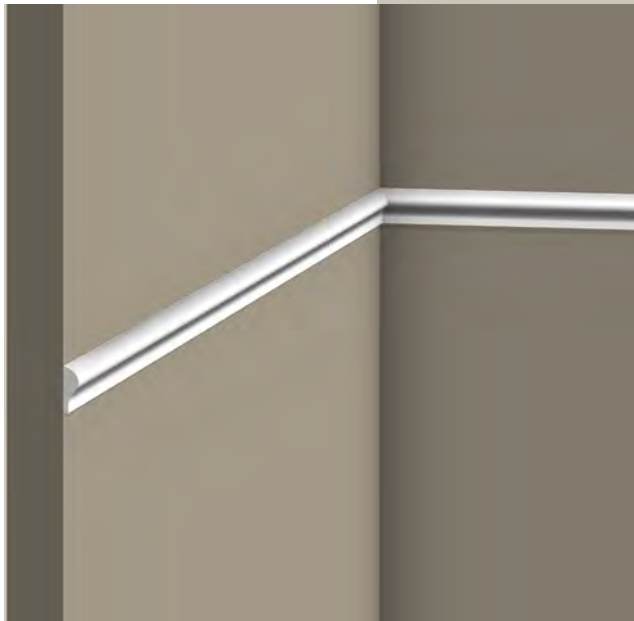

CAMARSAC

10.80 € /ml

1.3



3.5



Pour toute demande de corniche ornementée ou de création sur mesure vous pouvez nous contacter directement par mail ou téléphone.



GARABOS

PLATRIERIE - STAFF

05 56 32 00 23

accueil@garabos.com

lea.garabos@garabos.com